

Article number: 204060M1060A1S

Description: E+G levelling foot

GN 40-60-M10-60-A1-S

Note: S Without nut, External hexagon at the bottom

Measures

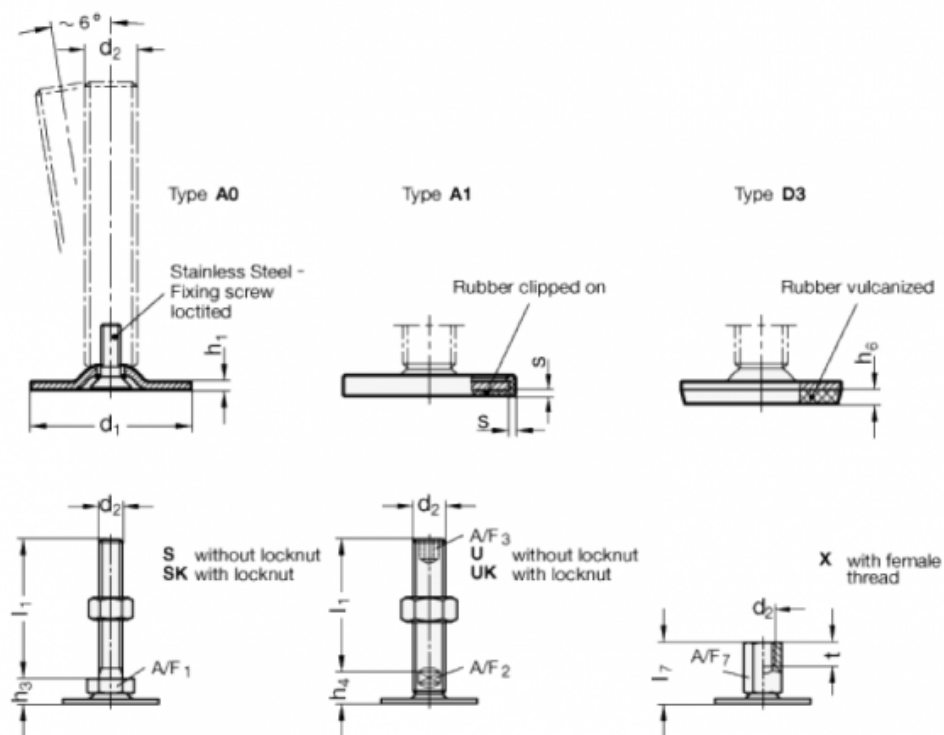

A/F1	= 17
d1	= 60
d2	= M10
h1	= 2.5
h3	= 11
h6	=
l1	= 60
s	= 1.5